

**KADERS DORMANTS**

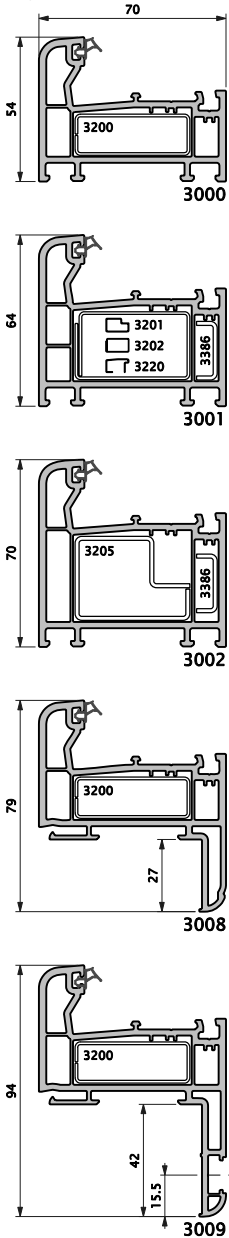

**STIJLEN TRAVERSES**

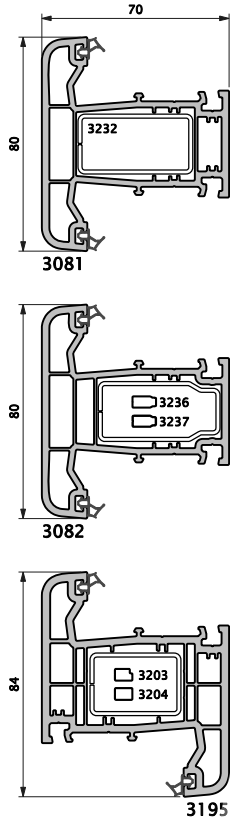

	50 mm	70 mm	90 mm
3081	3270	3273	3274
3082	3000	3001	3048
3091	3008	3002	3049
	3009	3017	3068
	3040	3018	3069
	3041	3081	
	3042	3082	
	3050	3091	
	3051		
	3052		
	3062		

3275 set kruisverbinding  
set raccord en croix

Voor meer info en advies  
kan u steeds terecht bij

**QUADRALIS**

3081	3271	3281
3082	3271	3282
3091	3271	3281
3062	3370 3371	3280
3068	3272	3280
3069	3272	3280

www.quadrallis.be

**STIJLEN/VLEUGELS TRAVERSES/OUVRANTS**

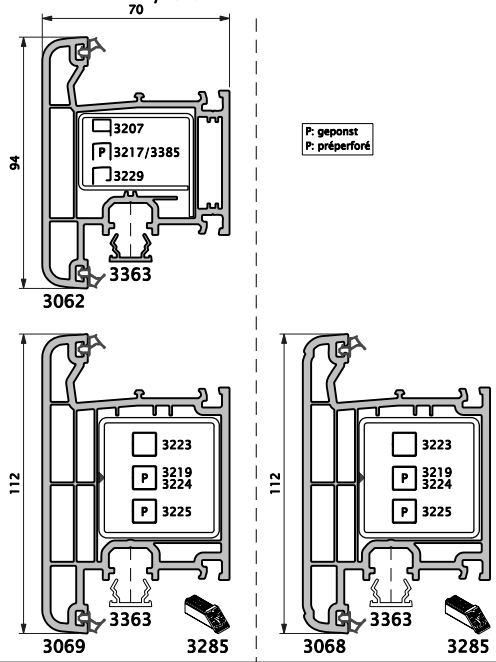

P: gepanst  
P: préperforé

**VLEUGELS OUVRANTS**

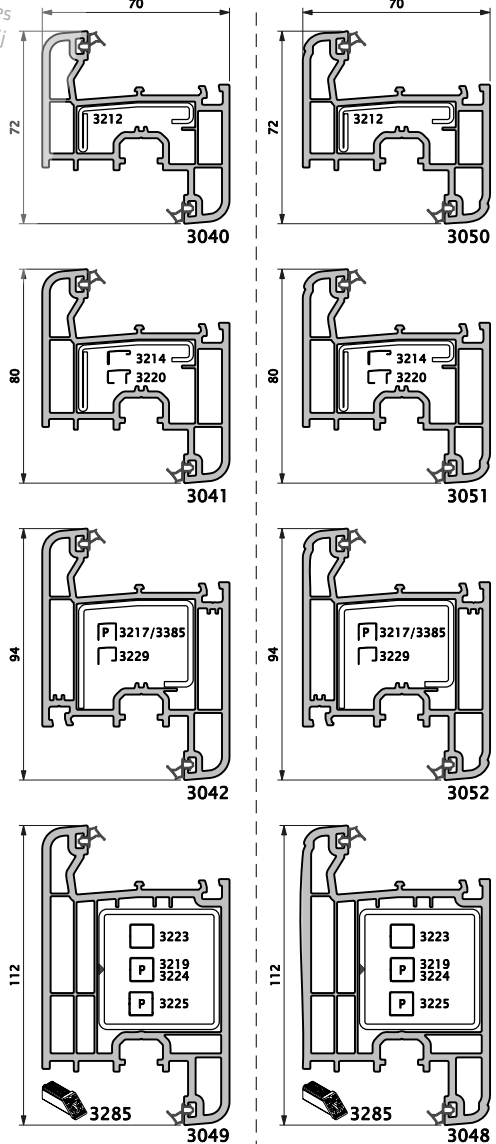

Alle gegevens zijn ter goede trouw en weerspiegelen onze huidige kennis. Zij kunnen derhalve niet tegen ons gebruikt worden. Technische wijzigingen voorbehouden.  
Tous les renseignements donnés reflètent l'état actuel de nos connaissances et ne peuvent en aucun cas être retenus contre nous. Modifications techniques réservées.

B-04/07-84768-9002-8123

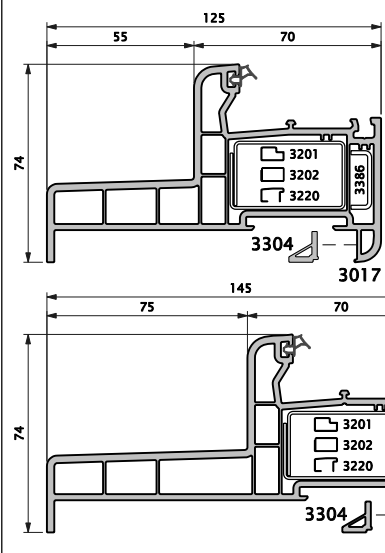

**MAKELAARS BATTEES**

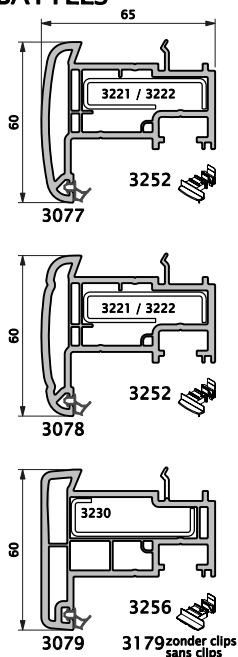

## FLEX

KADERS  
 DORMANTS  
 BLENDRAHMEN

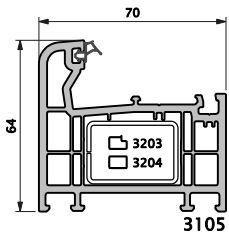

3105

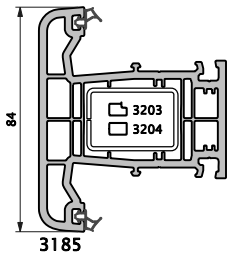

3185

STIJLEN  
 TRAVERSES  
 KÄMPFER

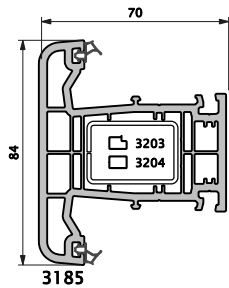

3185

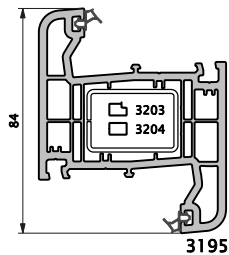

3195

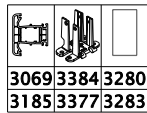

3069 3384 3280  
 3185 3377 3283

STIJLEN/VLEUGELS  
 TRAV/OUVR  
 KÄMPFER/FLÜGEL

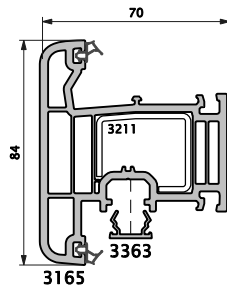

3165

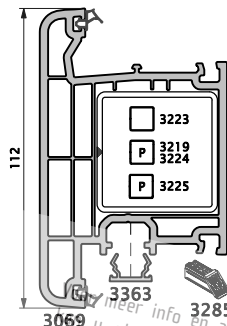

3069

P: geponst  
 P: préperforé

VLEUGELS  
 OUVRANTS  
 FLÜGEL

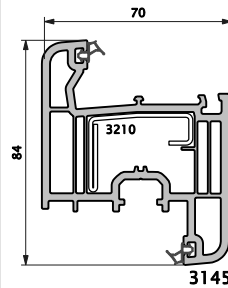

3145

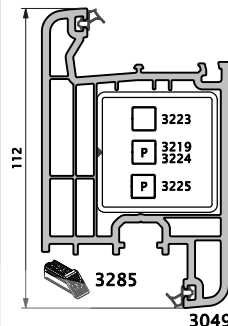

3049

MAKELAARS  
 BATTEES  
 STULPPROFIL

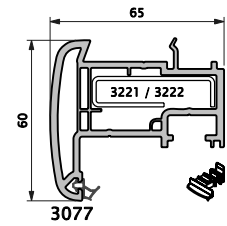

3077

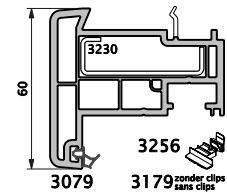

3079

3179 zonder clips  
 sans clips

## ROYAL

KADERS  
 DORMANTS  
 BLENDRAHMEN

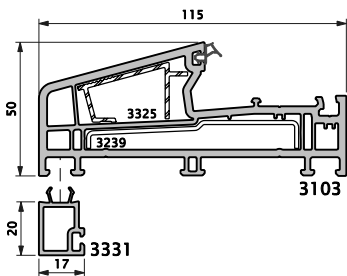

3103

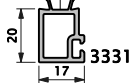

3331

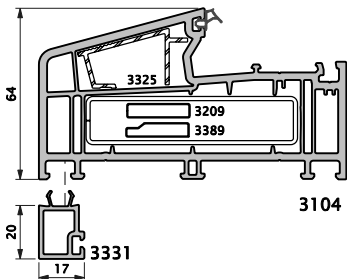

3104



3331

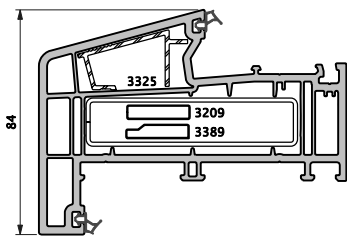

3114

STIJLEN  
 TRAVERSES  
 KÄMPFER

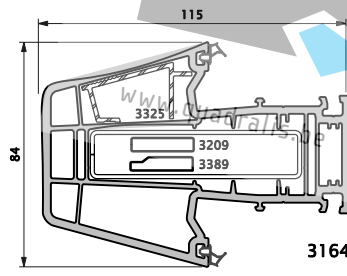

3164

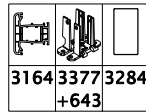

3164 3377 3284  
 +643

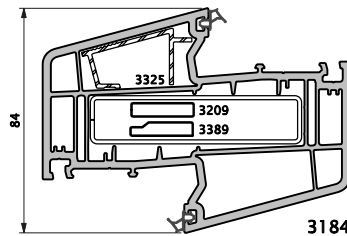

3184

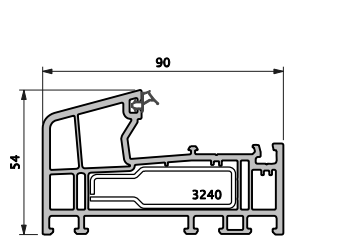

3111

VLEUGELS  
 OUVRANTS  
 FLÜGEL

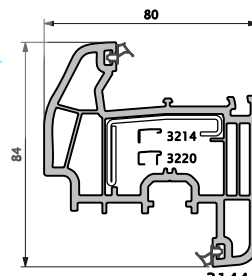

3144

OMKEERPROFIEL  
 RENVERSEUR  
 WECHSELPROFIEL

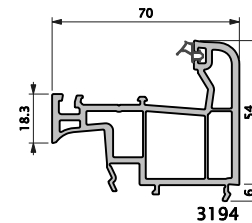

3194

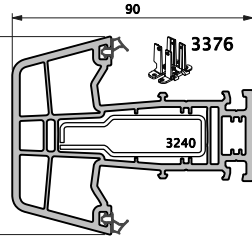

3112

MAKELAARS  
 BATTEES  
 STULPPROFIL

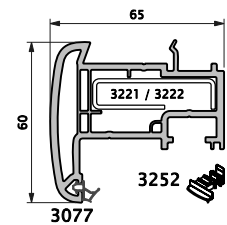

3077

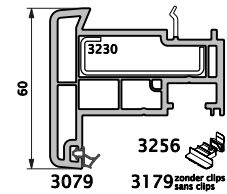

3079

3179 zonder clips  
 sans clips

TOEBEHOREN  
 ACCESSOIRES  
 ZUBEHÖR



2121



3299



3398



3399

Alle gegevens zijn ter goede trouw en weerspiegelen onze huidige kennis. Zij kunnen derhalve niet tegen ons gebruikt worden. Technische wijzigingen voorbehouden.  
 Tous les renseignements donnés reflètent l'état actuel de nos connaissances et ne peuvent en aucun cas être retenus contre nous. Modifications techniques réservées.

B-09/08-84770-9002-8123

# COMFORT

## KADERS DORMANTS

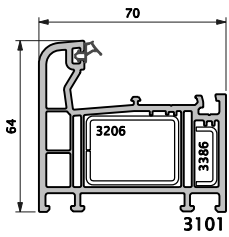

## STIJLEN TRAVERSES

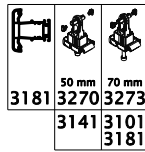
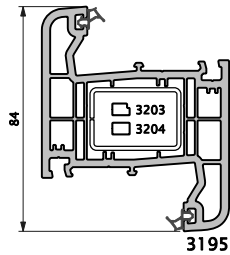
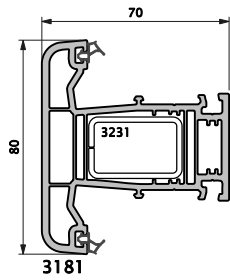

3275 set kruisverbinding  
set raccord en croix

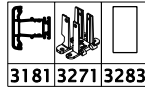

## VLEUGELS OUVRANTS

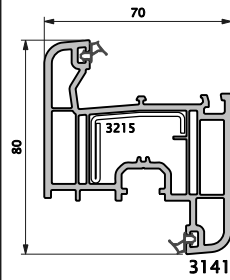

# LUX

## KADERS DORMANTS

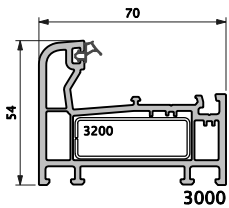

## STIJLEN TRAVERSES

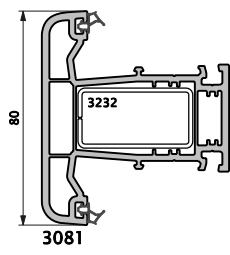
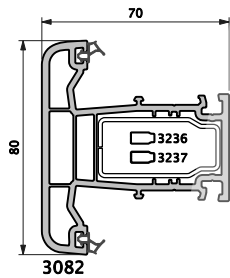

## VLEUGELS OUVRANTS

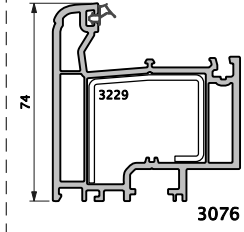
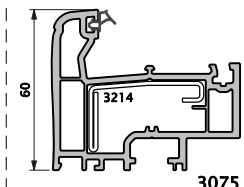
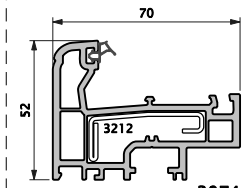
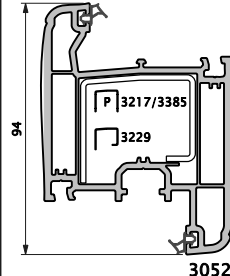
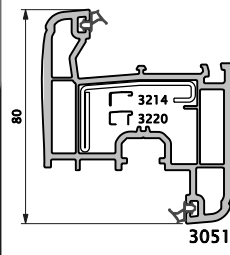
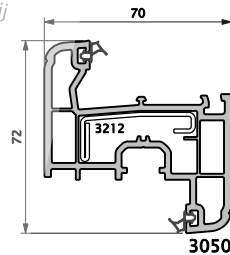
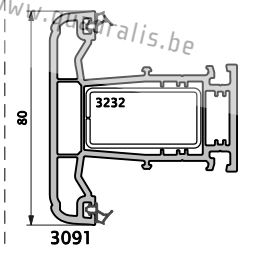
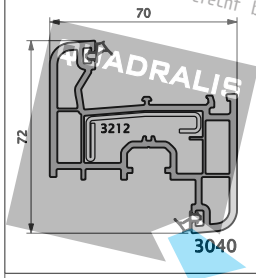

P: geponst  
P: préperforé

## TOEBEHOREN ACCESSOIRES

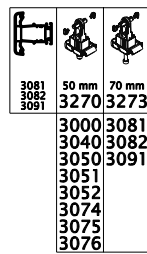
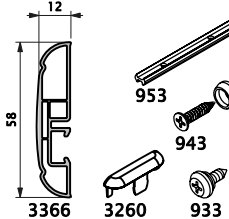
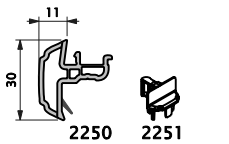

3275 set kruisverbinding  
set raccord en croix

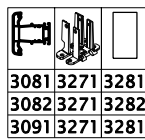

3081 3271 3281  
3082 3271 3282  
3091 3271 3281

# AUTENTICA

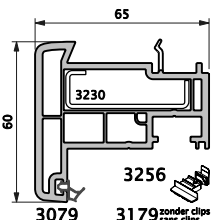
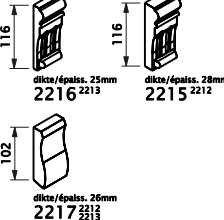
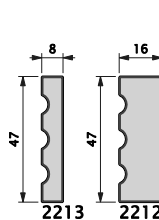
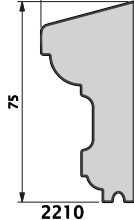
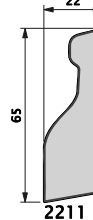
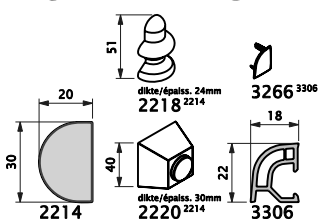

Alle gegevens zijn ter goede trouw en weerspiegelen onze huidige kennis. Zij kunnen derhalve niet tegen ons gebruikt worden. Technische wijzigingen voorbehouden. Tous les renseignements donnés reflètent l'état actuel de nos connaissances et ne peuvent en aucun cas être retenus contre nous. Modifications techniques réservées.

B-09/08-84787-9002-8123



## DORPELS / SEUILS

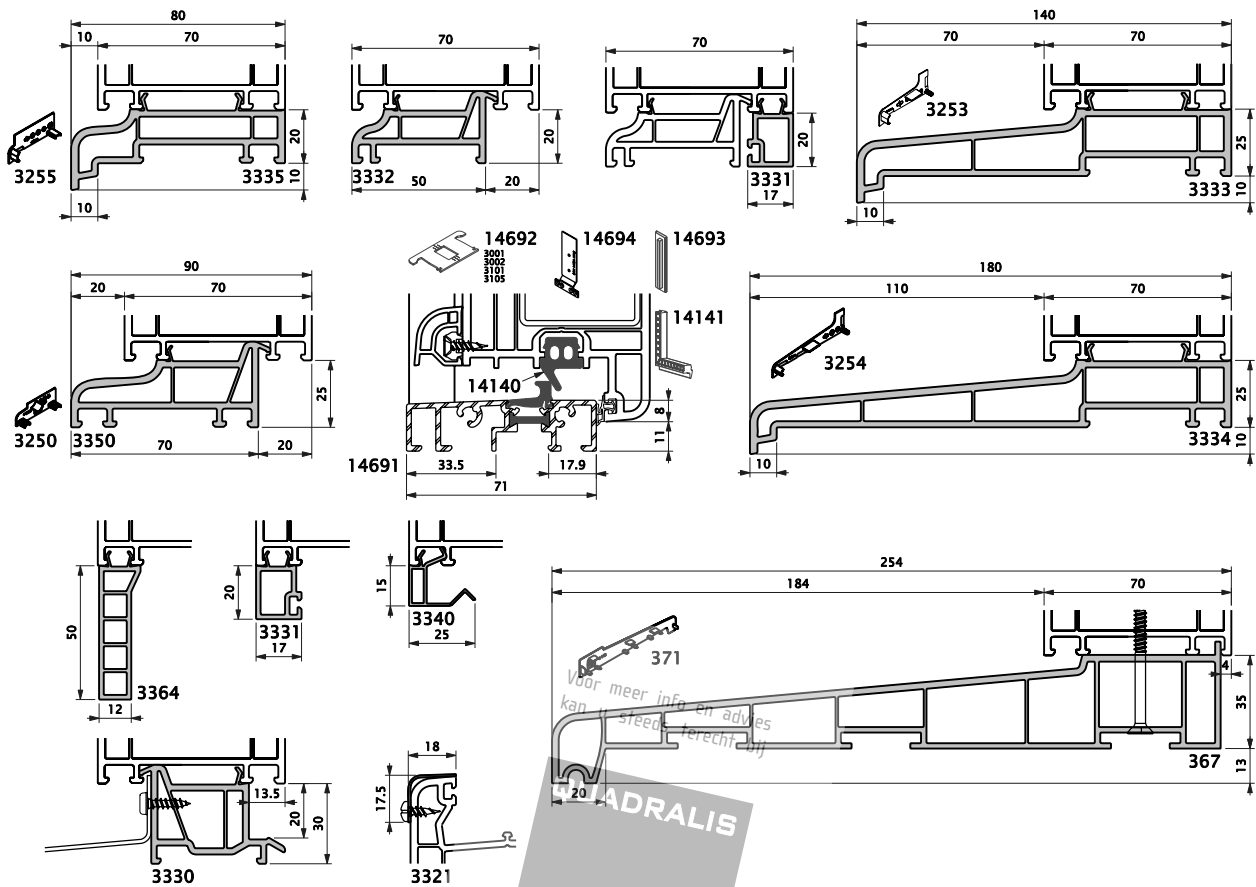

## KOPPELSYSTEMEN / SYSTEMES DE JONCTION

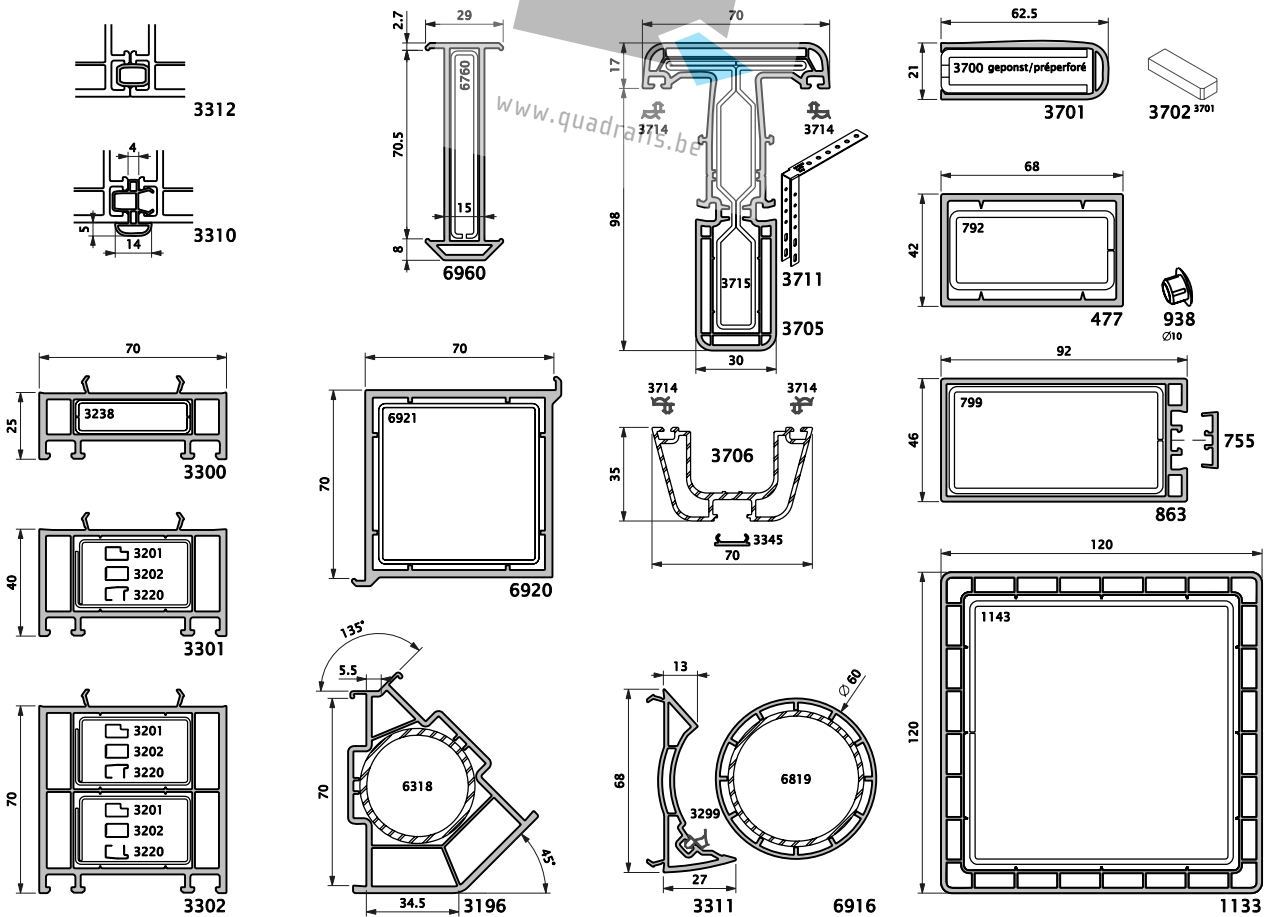

Alle gegevens zijn ter goede trouw en weerspiegelen onze huidige kennis. Zij kunnen derhalve niet tegen ons gebruikt worden. Technische wijzigingen voorbehouden.  
Tous les renseignements donnés reflètent l'état actuel de nos connaissances et ne peuvent en aucun cas être retenus contre nous. Modifications techniques réservées.

### GLASLATTEN / PARCLOSES

	BASIC	CONTEMPORARY	CUSTOM
5			
6			
7			
8			
9			
10			
11			
12			
17			
18			
19			
20			
21			
22			
23			
24			
25			
26			
27			
28			
30			
31			
32			
33			
34			
35			
36			
37			
40			
41			

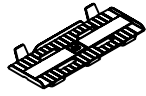

3251

### WATERLIJSTEN / JETS D'EAU

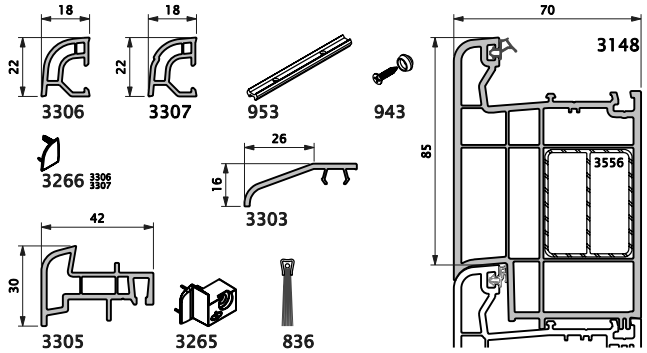

### KLEINHOUTEN / PETIT BOIS

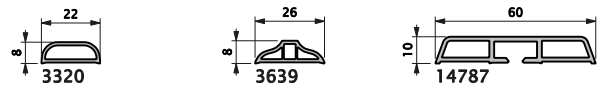

### DIVERSEN / DIVERS

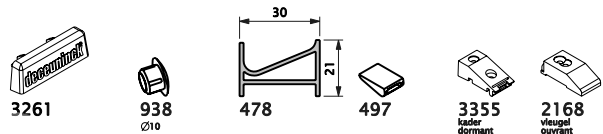

### DICHTINGEN / JOINTS

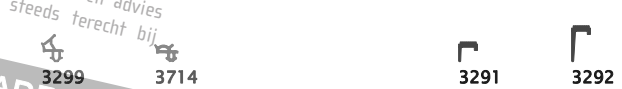

### VASTZETTINGSANKERS / PATTES DE SCHELEMENT

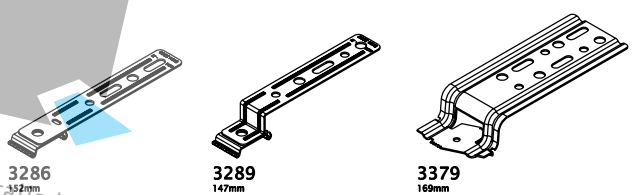

### AFWERKINGSPROFIELEN / PROFILES DE FINITION

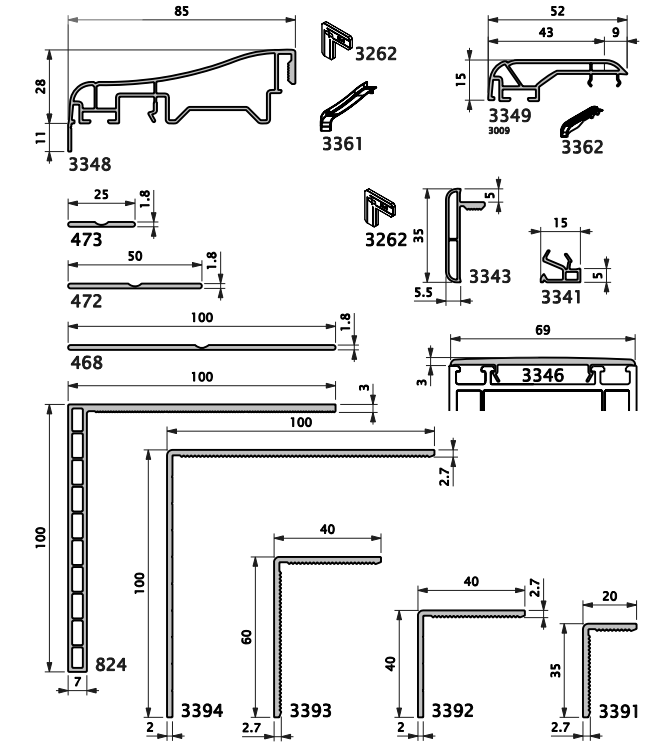

Alle gegevens zijn ter goede trouw en weerspiegelen onze huidige kennis. Zij kunnen derhalve niet tegen ons gebruikt worden. Technische wijzigingen voorbehouden. Tous les renseignements donnés reflètent l'état actuel de nos connaissances et ne peuvent en aucun cas être retenus contre nous. Modifications techniques réservées.

B-09/08-84771-9002-8123

# MONORAIL

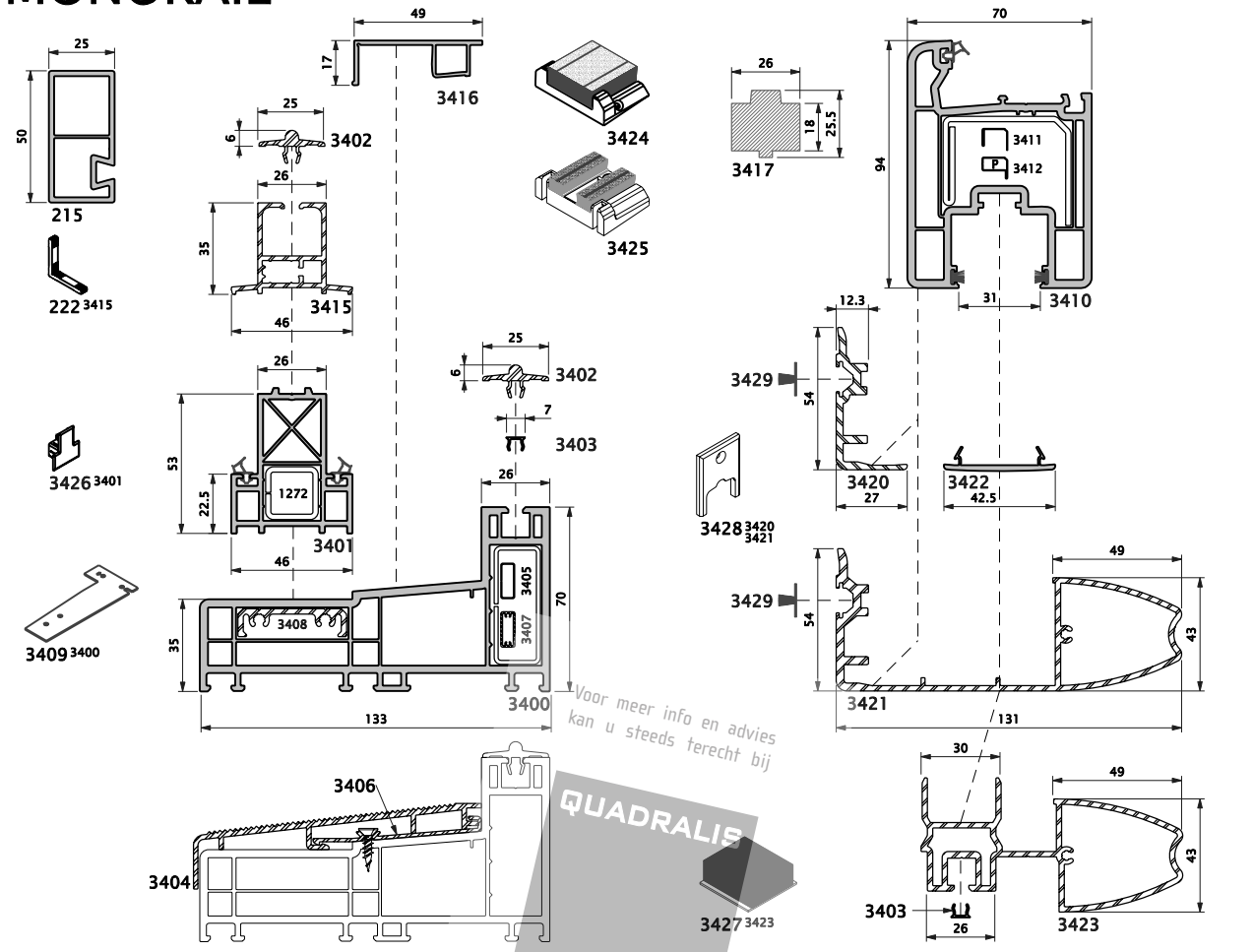

QUADRALIS

# VERANDA

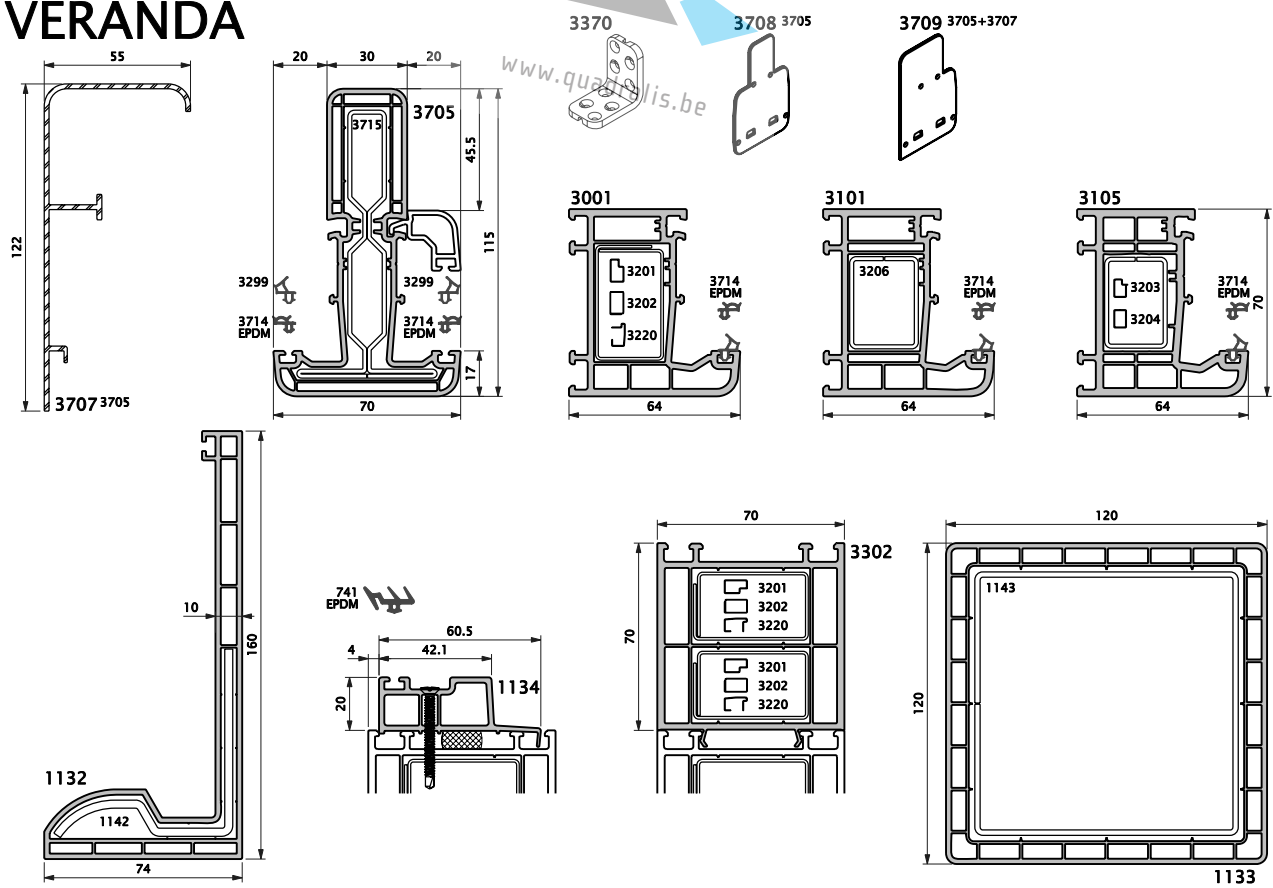

Alle gegevens zijn ter goede trouw en weerspiegelen onze huidige kennis. Zij kunnen derhalve niet tegen ons gebruikt worden. Technische wijzigingen voorbehouden. Tous les renseignements donnés reflètent l'état actuel de nos connaissances et ne peuvent en aucun cas être retenus contre nous. Modifications techniques réservées.

